

# LED Industrie- und Raumbelichtung

## LED plafonnier en applique - Line air luminaire suspendu

### Line - plafonnier en applique LED 230 V



- reproduction des couleurs: Ra >84
- protection class: IP40
- alu brossé blanc
- dimensions (lxh): 50 mm x 55 mm

	couleur	watts	couleur lumière	lumen	longueur
79.60220.30	aluminium	12.6 W	3000 K	2200 lm	580 mm
79.60221.30	aluminium	18.8 W	3000 K	3300 lm	870 mm
79.60222.30	aluminium	25.0 W	3000 K	4400 lm	1140 mm
79.60223.30	aluminium	31.3 W	3000 K	5500 lm	1430 mm
79.60220.40	aluminium	16.7 W	4000 K	2230 lm	580 mm
79.60221.40	aluminium	37.5 W	4000 K	4350 lm	870 mm
79.60222.40	aluminium	48.3 W	4000 K	5630 lm	1140 mm
79.60223.40	aluminium	61.3 W	4000 K	7160 lm	1430 mm

- Sans stock, délai de livraison env.1 semaine.
- Autre version sur demande.

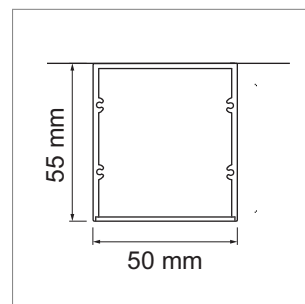

### Line air - lampe à Suspension LED 230 V



- reproduction des couleurs: Ra >84
- protection class: IP40
- Alu brossé blanc
- Support de Montage: 2000 mm
- câble de raccordement: 2000 mm claire
- dimensions (lxh): 50 mm x 55 mm

	couleur	watts	couleur lumière	lumen	longueur
79.60224.30	aluminium	12.6 W	3000 K	2200 lm	580 mm
79.60225.30	aluminium	18.8 W	3000 K	3300 lm	870 mm
79.60226.30	aluminium	25.0 W	3000 K	4400 lm	1140 mm
79.60227.30	aluminium	31.3 W	3000 K	5500 lm	1430 mm
79.60224.40	aluminium	16.7 W	4000 K	2230 lm	580 mm
79.60225.40	aluminium	37.5 W	4000 K	4350 lm	870 mm
79.60226.40	aluminium	48.3 W	4000 K	5630 lm	1140 mm
79.60227.40	aluminium	61.3 W	4000 K	7160 lm	1430 mm

- Sans stock, délai de livraison env.3 semaine.
- Autre version sur demande.

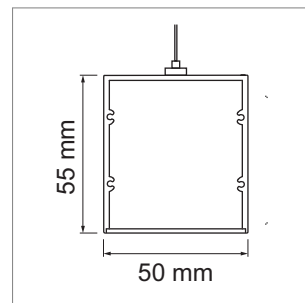

Informations techniques et légende des icônes sur les pages A-1.79.